

범 위	등 급			공 차		
	I	II	III	I	II	III
0 ~ 4 이하	±0.1	±0.2	±0.3			
4 ~ 16 이하	±0.2					
16 ~ 63 이하	±0.3	±0.3	±0.5			
63 ~ 250 이하	±0.5	±0.5	±0.8			
250 ~ 1000 이하	±0.8	±0.8	±1.2			
1000 ~	±1.5	±1.5	±2.3			
각 도						
표면거칠기						

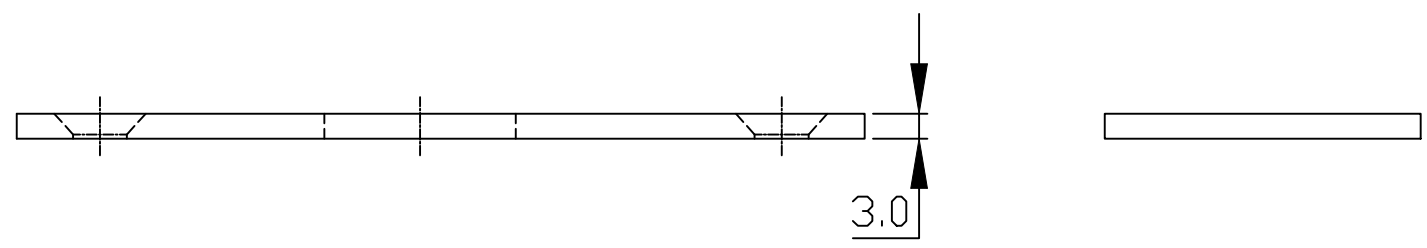
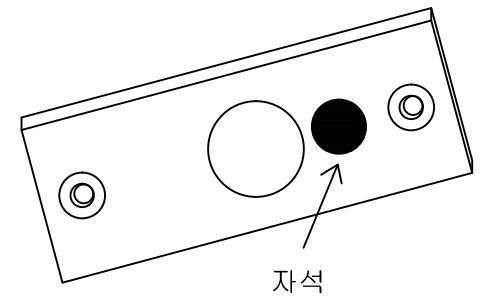
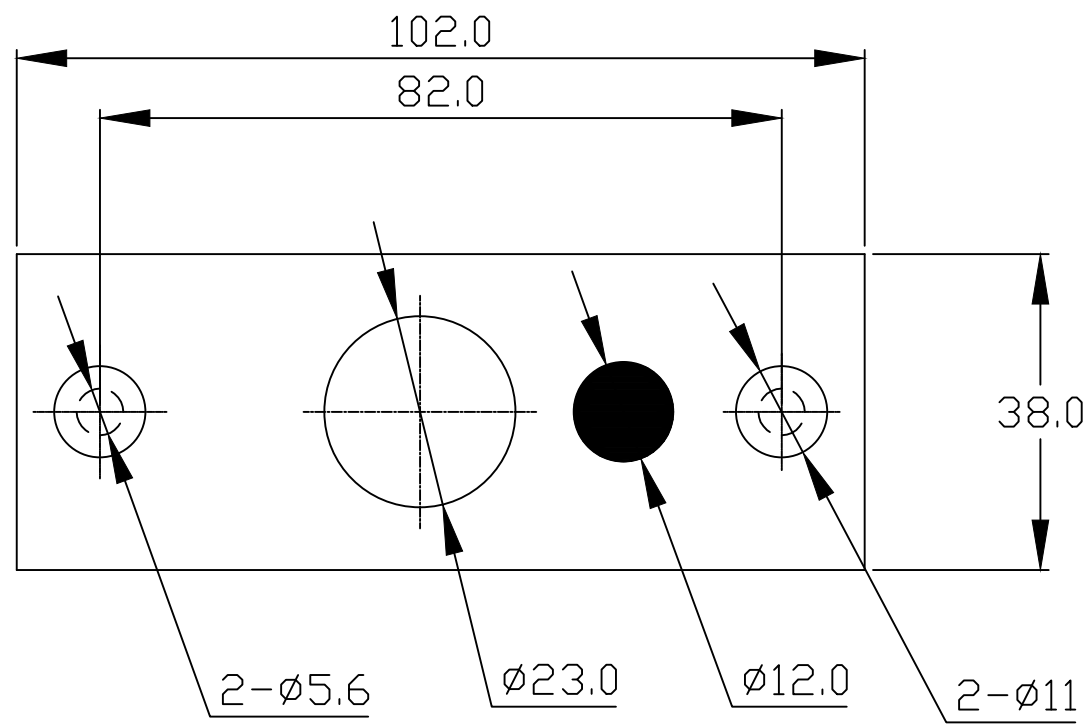

NOTE

1. - 지시없는 모서리 C0.5

C	B	A	NO.	DWG. NO.	PART NAME	SPEC'	MATERIAL	Q'TY	REMARK
						▶ MATERIAL	▶ MODEL	▶ Q'TY	▶ SIZE A3
						▶ SURFACE	▶ PART NAME		▶ SCALE
						▶ DRAWN	▶ REVIEW	▶ APPROVAL	받이판
							▶ DWG. NO. DB-1850-002		▶ SHEET
						▶ CODE			▶ REV.