

등급	공차		
	I	II	III
0 ~ 4 이하	±0.1	±0.2	±0.3
4 ~ 16 이하	±0.2	±0.3	±0.5
16 ~ 63 이하	±0.3	±0.5	±0.8
63 ~ 250 이하	±0.5	±0.8	±1.2
250 ~ 1000 이하	±0.8	±1.2	±2.3
1000 ~	±1.5	±2.3	
각도			
표면거칠기			

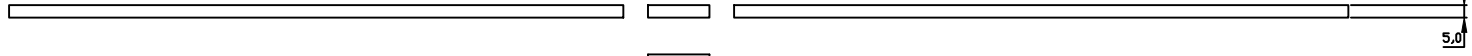
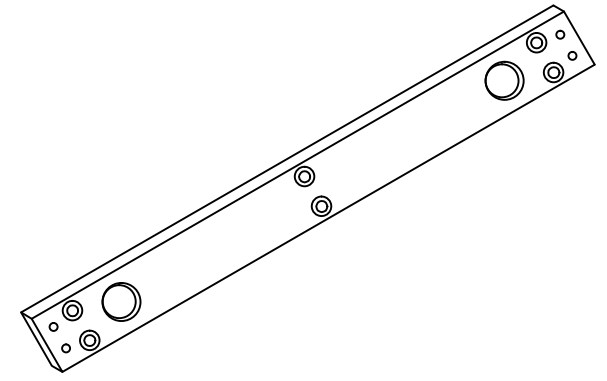
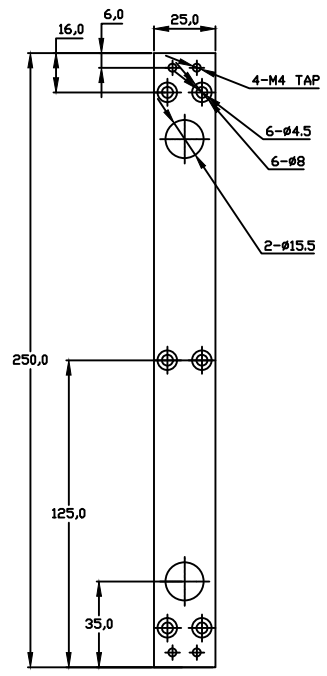

NOTE

1. -ANODIZING : SILVER / 연질 / 반광

C	B	A	NO.	DWG. NO.	PART NAME	SPEC'	MATERIAL	Q'TY	REMARK	
					▶ MATERIAL	<b>AL6060</b>	▶ MODEL	▶ Q'TY	▶ SIZE	A3
					▶ SURFACE	<b>ANODIZING</b>	▶ PART NAME			▶ SCALE
					▶ DRAWN	▶ REVIEW	▶ APPROVAL			
				<b>Y.H.HAN</b>	<b>C.S.KIM</b>	<b>C.S.KIM</b>	▶ DWG. NO.			▶ SHEET
							▶ CODE			▶ REV.
							<b>설치판</b>			
							<b>DB-400AL-002</b>			